

# Montageanleitung

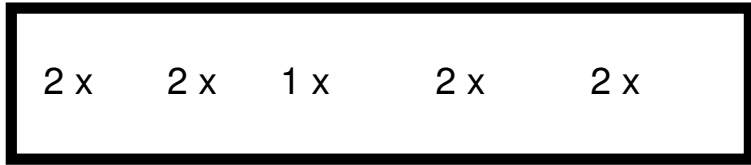

## 1a Deckenmontage

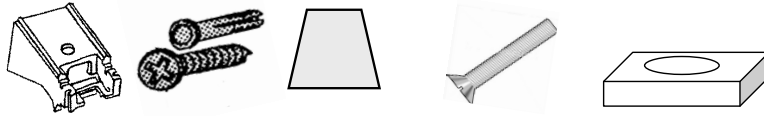
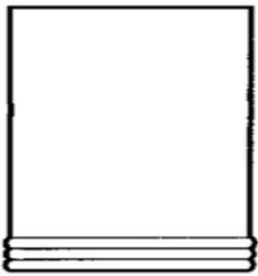
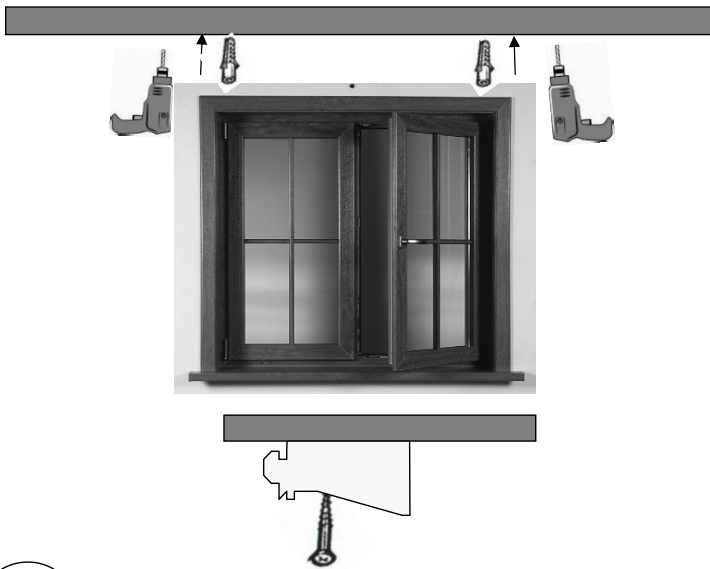

## 1b Wandmontage

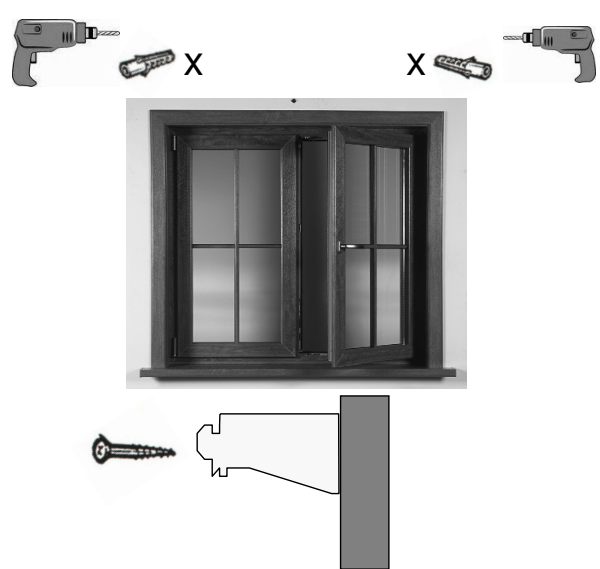

## 1c Schienenmontage

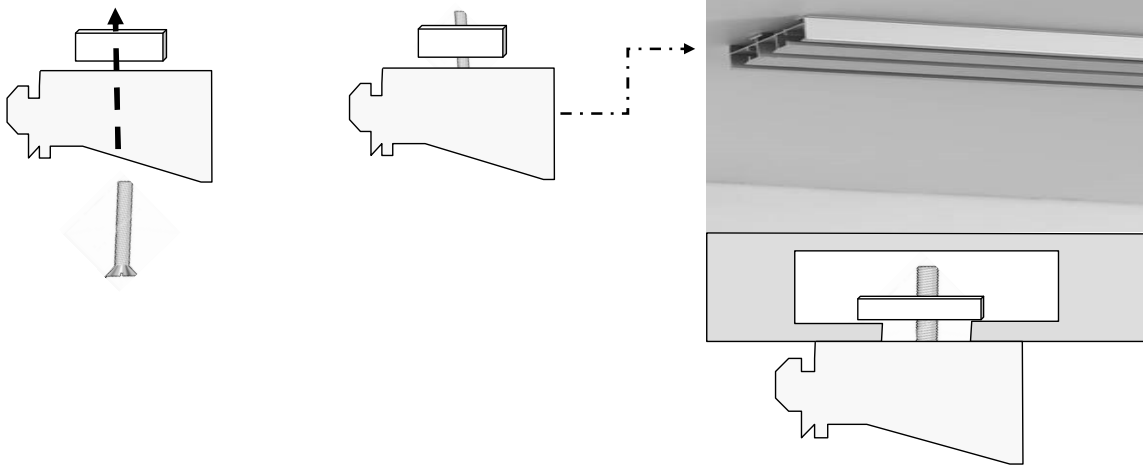

1d **Fensterrahmenmontage mit Klemmträger ( Sonderzubehör)**

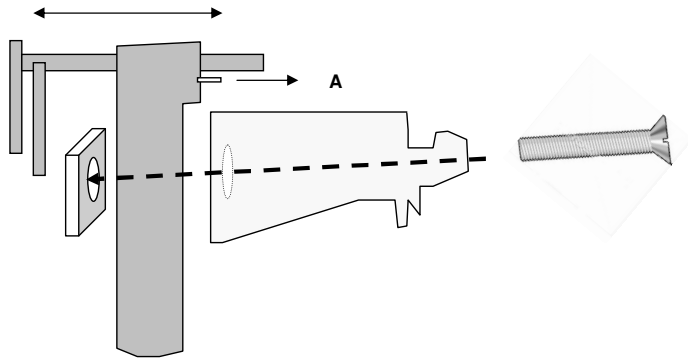

A = Rasterzunge  
zum Lösen /Verschieben die Rasterzunge A drücken

Raffroloträger mittels Schraube und Mutter mit dem Klemmträger verbinden

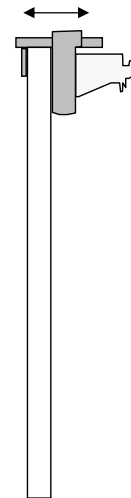
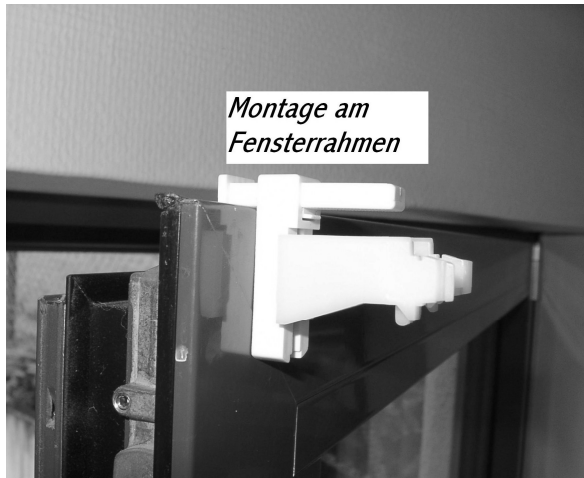

Klemmträger auf den Fensterrahmen setzen und andrücken.  
Zum Lösen des Klemmträgers die Rasterzunge A drücken ( siehe oben)

2

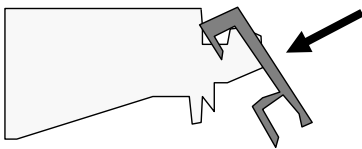

Klick

3a

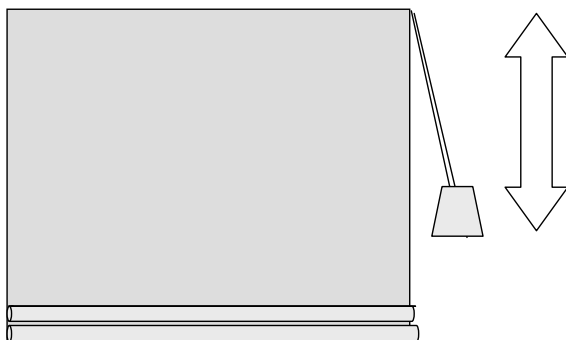

3b

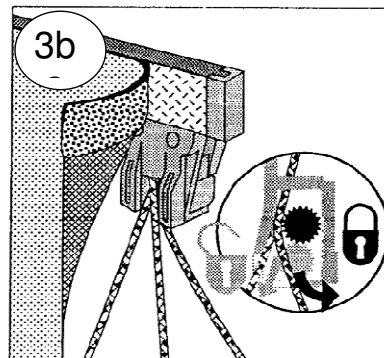

Demontage  
beim Waschen

1.

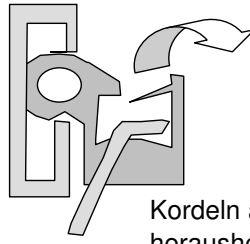

Kordeln aus den Führungen  
herausheben

2.

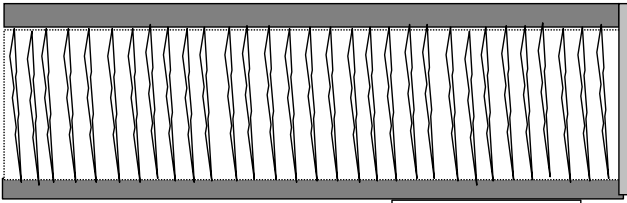

Bolzen am Schnurschloß  
öffnen

drücken

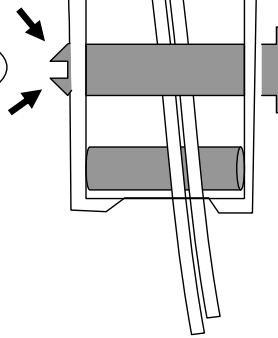

Kordeln herausnehmen

